

RDT-5

Manual for use and maintenance



RDT-5

Triple Phase Digital Thermostat

Ag/MIS/UmGB-2479-07/17 Rev 1.3
P/N: 116343

RDT-5

Manual for use and maintenance

Revision: N.1.3 of 05.2023

Product Software: N/A

This manual for use and maintenance is an integral part of the apparatus together with the attached technical documentation.

This document is destined for the user of the apparatus: it may not be reproduced in whole or in part, committed to computer memory as a file or delivered to third parties without the prior authorization of the assembler of the system.

Munters reserves the right to effect modifications to the apparatus in accordance with technical and legal developments.

Index

<i>Chapter</i>		<i>page</i>
1	INTRODUCTION.....	5
	1.1 Disclaimer.....	5
	1.2 Introduction	5
	1.3 Notes	5
2	PRECAUTIONS.....	6
3	INTRODUCTION TO THE RDT-5.....	6
	3.1 Features	7
	3.2 Indicator LEDs.....	7
	3.3 Display Abbreviations	8
4	USING THE RDT-5.....	9
	4.1 RDT-5 Keyboard	9
	4.2 Cold Start.....	10
	4.3 Software Version	10
	4.4 RDT-5 Configuration.....	10
	4.4.1 Quick Start.....	10
	4.4.2 Reading the Main Screen	11
	4.4.3 Displaying the Current Temperature.....	11
	4.4.4 Configuring the Basic Settings	11
	4.4.5 Configuring the Stage Activation Temperature	12
	4.4.6 Configuring the Temperature Curve.....	12
5	INSTALLATION	14
	5.1 Mounting.....	14
	5.2 Wiring.....	14
	5.2.1 Selecting Heating or Cooling Functions.....	15
	5.2.2 RBU – RDT-5 Wiring.....	16
	5.2.3 RDT-5 – RTS Wiring.....	17
	5.2.4 Powering the RDT-5.....	17
	5.2.5 Alarm Wiring.....	18
	5.2.6 Platinum – RDT-5 Wiring	18
	5.2.7 Platinum – RDT-5 Communication	20
	5.3 Configuring the RS-485 Communication	22
6	SPECIFICATIONS.....	24
7	APPENDIX A: SETTING THE TEMPERATURE CURVE IN LEGACY SOFTWARE.....	25
8	WARRANTY	26

1 Introduction

1.1 Disclaimer

Munters reserves the right to make alterations to specifications, quantities, dimensions etc. For production or other reasons, subsequent to publication. The information contained herein has been prepared by qualified experts within Munters. While we believe the information is accurate and complete, we make no warranty or representation for any particular purposes. The information is offered in good faith and with the understanding that any use of the units or accessories in breach of the directions and warnings in this document is at the sole discretion and risk of the user.

1.2 Introduction

Congratulations on your excellent choice of purchasing a RDT-5!

In order to realize the full benefit from this product it is important that it is installed, commissioned and operated correctly. Before installation or using the thermostat, this manual should be studied carefully. It is also recommended that it is kept safely for future reference. The manual is intended as a reference for installation, commissioning and day-to-day operation of the Munters Controllers.

1.3 Notes

Date of release: May 2014

Munters cannot guarantee to inform users about the changes or to distribute new manuals to them.

NOTE All rights reserved. No part of this manual may be reproduced in any manner whatsoever without the expressed written permission of Munters. The contents of this manual are subject to change without notice.

2 Precautions

- Always connect temperature and sensor shields to earth ground. Avoid mixing high voltage wiring with sensor and low voltage wiring.
- Keep the controller as far as possible from heavy contactor boxes and other sources of electrical interference.
- Only a trained installer may install this unit, in accordance with the local National Electrical Codes.

3 Introduction to the RDT-5

The Triple Phase RDT-5 is a five stage digital thermostat that works in conjunction with Controllers. The RDT-5 works as a stand-alone unit, using its own temperature to activate the backup system.

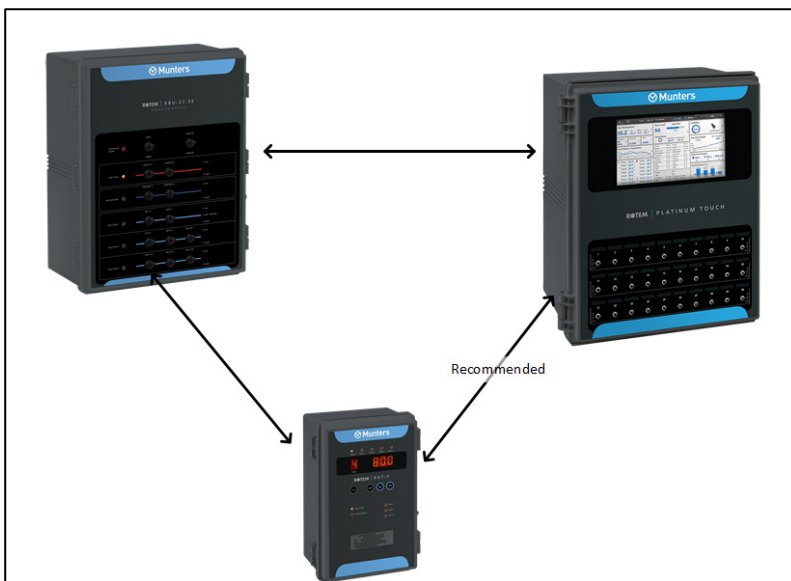

Figure 1: RDT-5 Block Diagram

Digital thermostats provide highly accurate readings, ensuring that both the Platinum Controller function according to specifications.

3.1 Features

- Five independent thermostats
- Each stage can be set to backup cooling or heating operations
- 10 point temperature curve
- Works as a standalone or with Platinum (can be programmed via the Platinum; refer to *Configuring the Temperature Curve*, page 12)
- Displays:
 - stage temperature
 - state
 - system information
- Alarm logic detects failures
- Comes equipped with built-in power and input protection
- No software needed to run the unit; software is used to configure the unit only

3.2 Indicator LEDs

The following table defines the LED indicators when the LED is lit.

Table 1: LED Indicators

LED	Definition of Lit LED
Stage 1 – 5	Thermostats are operational
System OK	System functioning properly
Check System	CPU is not functioning
Line 1	Power source one is supplying power
Line 2	Power source two is supplying power
Line 3	Power source three is supplying power

NOTE The System OK and Check System LEDs are never both lit.

3.3 Display Abbreviations

The RDT-5 three (3) digit display window shows different abbreviations. The following table explains these abbreviations.

Table 2: RDT-5 Abbreviations

Abbreviation	Meaning
-t-	Temperature
dif	Differential (temperature difference between the temperature curve and the required temperature to operate coolers or heaters)
F.d	First day
F.t	First temperature
S.d	Second day
S.t	Second temperature
L.d	Last day
L.t	Last temperature
PrE	Standalone mode
Aut	Platinum mode
C	Centigrade
F	Fahrenheit
day	Current growth day
Hr	Hour
nᵐi	Minute

4 Using the RDT-5

The following sections describe how to use the RDT-5.

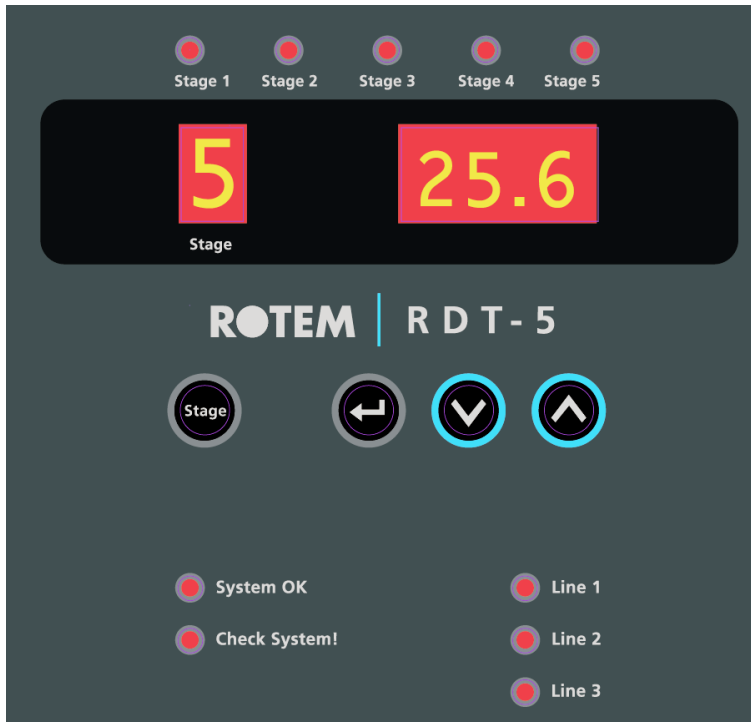

Figure 2: RDT-5 Front Panel

- RDT-5 Keyboard
- Cold Start
- Software Version
- RDT-5 Configuration

4.1 RDT-5 Keyboard

- Use the **Stage** key to navigate between the stages. The current stage is always displayed in the one digit window (Reading the Main Screen).
- Use the **Select** key to:
 - display the current temperature (Displaying the Current Temperature)
 - set the target temperatures (Configuring the Basic Settings)
- Use the **Down** key to:
 - decrease parameter settings
 - set the temperature curve (Configuring the Temperature Curve)
- Use the **Up** key to
 - increase parameter settings
 - set the RDT-5 parameters (Configuring the Basic Settings)

4.2 Cold Start

Cold Start returns the unit to its default settings. Only perform this procedure when advised to do so by your dealer or a Munters technician.

To perform a Cold Start:

1. Disconnect power.
2. Apply power while pressing **Select**, **Up Arrow**, and **Down Arrow**.
3. When Cold Start Screen appears, press **Select**.

4.3 Software Version

After applying power, RDT-5:

- Loads the temperature and growth day settings
- Displays the software version on the screen for a few seconds

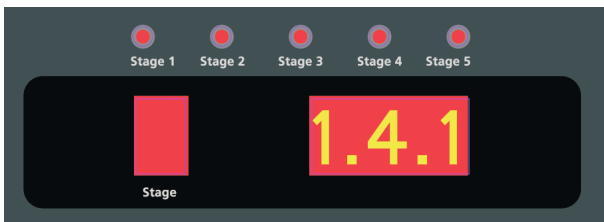

Figure 2: Software Version

NOTE If the RDT-5 cannot load the settings, it displays ----- in place of the software version. These lines should disappear within a short time. If the lines remain in place, reapply power. If they still remain in place, contact Technical Support.

NOTE RDT-5 retains all settings in the event of any power cut.

4.4 RDT-5 Configuration

The following sections explain how to configure the RDT-5.

- Quick Start
- Reading the Main Screen
- Displaying the Current Temperature
- Configuring the Basic Settings
- Configuring the Stage Activation Temperature
- Configuring the Temperature Curve

4.4.1 QUICK START

This section describes the basic setup steps. For more detailed information refer to the subsequent sections.

1. Press **Select** **quickly**. The unit displays the current temperature.
2. Press **Down Arrow** for three seconds. Set the general settings.
3. Press **Select** for three seconds. The 3 digit display shows current stage activation temperature and “dif”. Use the arrow keys to modify the dif.

4. Press **Up Arrow** for three seconds. The three digits display F.d and 1 (Stage 1). Use the arrow keys to set the day.

4.4.2 READING THE MAIN SCREEN

The RDT-5 Main Screen displays the:

- current stage
- **target** temperature

In Figure 2, the current stage is Stage 5 and the target temperature is 20.6° C.

To navigate between stages:

- Press the **Stage** key. The Stage display and corresponding target temperature changes.

4.4.3 DISPLAYING THE CURRENT TEMPERATURE

To display the current temperature:

1. Press **Select** **quickly**.

The 3 digit display shows current temperature and “-t”.

2. Press **Stage** to navigate between stages.

NOTE After 10 seconds of inactivity on the keyboard, the display returns to the Main Screen.

4.4.4 CONFIGURING THE BASIC SETTINGS

There are several parameter settings which must be set before configuring target temperatures and temperature curves. These parameters are not displayed.

- Mode
- Centigrade/Fahrenheit
- Current growth day
- Clock time (hour/minute)

The RDT-5 can work as in standalone mode (PrE) or in conjunction with the Platinum controller (Aut). In standalone mode, the RDT-5 sets the target temperature curve (and the differential related to it). When working with the Platinum, the RDT-5 sets the differential related to the Platinum target temperature.

To set the basic settings:

1. Press **Down Arrow** for three seconds.

The 3 digit display shows **PrE** or **Aut**.

2. Use the arrow keys to select **PrE**.

3. Press **Select**.

Use the arrow key to select **C** or **F**.

4. Press **Select**.

The 3 digit display shows **dAY** and the current setting.

5. Use the arrow keys to set the current day.

Press **Select**.

6. The 3 digit display shows **Hr** and the current hour value.

Use the arrow keys to set the hour.

7. Press **Select**.

The 3 digit display shows **nri** and the current minutes value.

8. Use the arrow keys to set the minutes

9. Press **Select**.

- Values are saved to memory.
- The display returns to the Main Screen.

4.4.5 CONFIGURING THE STAGE ACTIVATION TEMPERATURE

The stage activation temperature determines when cooling and heating operations take place. RDT-5 enables setting a separate stage activation temperature for each stage.

NOTE Configure each relay to cool or heat; refer to Selecting Heating or Cooling Functions, page 15.

To set the stage activation temperature:

1. Press **Select** for three seconds.

The 3 digit display shows current stage activation temperature and “dif”.

2. Using the arrow keys, modify the parameter.

3. Press **Stage** to switch to the next stage and modify as required.

4. Repeat as needed.

5. Press **Select** to save the settings.

- Values are saved to memory.
- The display returns to the Main Screen.

NOTE After 60 seconds of inactivity on the keyboard, the display returns to the Main Screen.

4.4.6 CONFIGURING THE TEMPERATURE CURVE

RDT-5 Version 1.0.2 enables setting a temperature curve consisting of 10 lines. In each line, define the day and the target temperature.

Curve Point	Day	Target Temperature
1	1	74° F
2	15	76° F
10	42	78° F

To configure the temperature curve:

1. Press **Up Arrow** for three seconds.

The screen displays **P** (curve point) and a number (the day number).

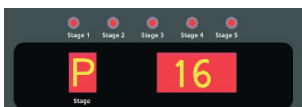

The screen toggles and displays a number (the curve point number) and **dAY**.



2. Press the arrow keys to set the day (Range: 1 to 300).

3. Press Select.

The screen displays P (curve point) and a number (the target temperature).

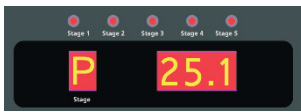

The screen toggles and displays a number (the curve point number) and trG.

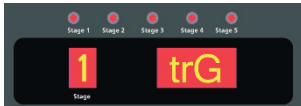

4. Use the arrow keys to set that day's target temperature (Range: 0.5° to 50° C).

5. Press Select.

6. Repeat this process for each required line.

- A "0" appears for line 10.
- When you complete line 10, the display returns to the Main Screen.
- Values are saved to memory.
- Entering a zero for a day value deletes the day and the temperature.

• Additional details:

- Even when connected to a controller, these settings are saved in the RDT-5 only.
- Platinum Version 5.10 (and higher) supports defining the temperature curve using Platinum software. Refer to the Platinum User Manual for complete details.
- After 60 seconds of keyboard inactivity, the display automatically returns to the Main Screen.
- Users employing Version 1.0.1, refer to Appendix A: Setting the Temperature Curve In Legacy Software, page 25.

5 Installation

The following sections detail the installation procedures.

- Mounting
- Wiring
- Configuring the RS-485 Communication

5.1 Mounting

When installing the unit, observe the following rules:

- The RDT-5 must be installed by an authorized electrician. When installing the unit, disconnect the power to avoid electrical shock and damage.
- To avoid exposing the unit to harmful gases or high humidity, it is recommended to install it in the service room.
- Installation Category (Overvoltage Category) III.
- The power supply to the controller should be protected by a 5 Amps circuit breaker.

To mount the RDT-5:

1. Mount the RDT-5 vertically on the wall, using the four supplied screws through the mounting holes.



Figure 3: Mounting Hole

2. To open the enclosure, unclip the two left-side clips in the front.
3. On the side of the box, drill holes to size for routing cables.
4. Connect the wires according to the wiring diagrams detailed in the next section.

5.2 Wiring

The following sections detail the RDT-5 wiring. Figure 4 displays the RDT-5 layout.

- Selecting Heating or Cooling Functions, page 15
- RDT-5 – RTS Wiring, page 17
- Platinum – RDT-5 Wiring, page 18
- Powering the RDT-5, page 17
- Alarm Wiring, page 18

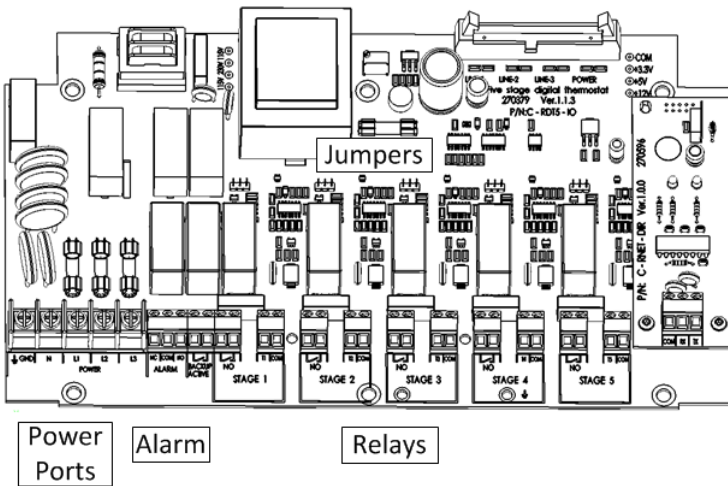

Figure 4: RDT-5 Boards and Ports

5.2.1 SELECTING HEATING OR COOLING FUNCTIONS

Each relay must be set to operate a heater or cooler (Figure 5).

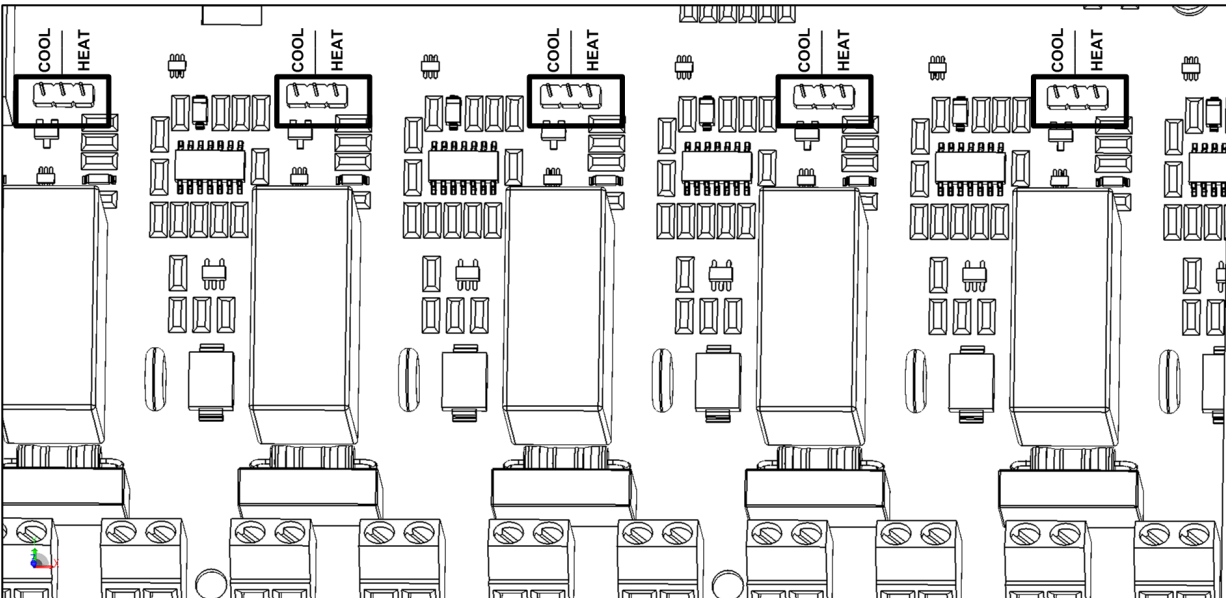

Figure 5: Jumpers Locations

To set the relay function:

- On each relay, place the jumper over the required pins. Figure 6 displays two examples.

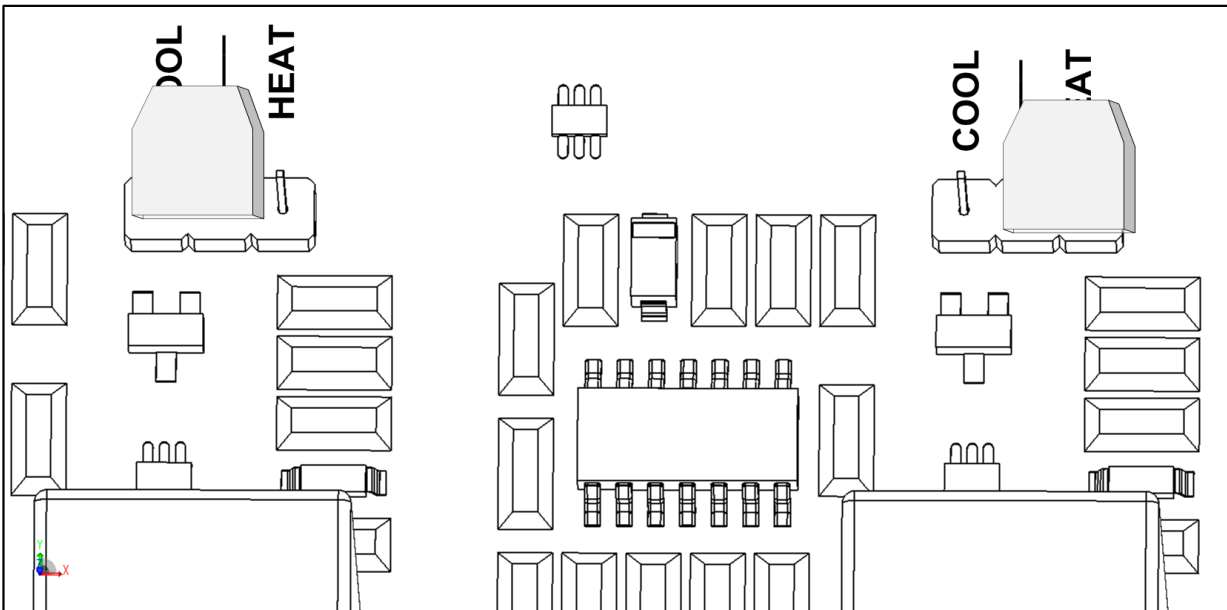

Figure 6: Cooling and Heating Jumpers

5.2.2 RBU – RDT-5 WIRING

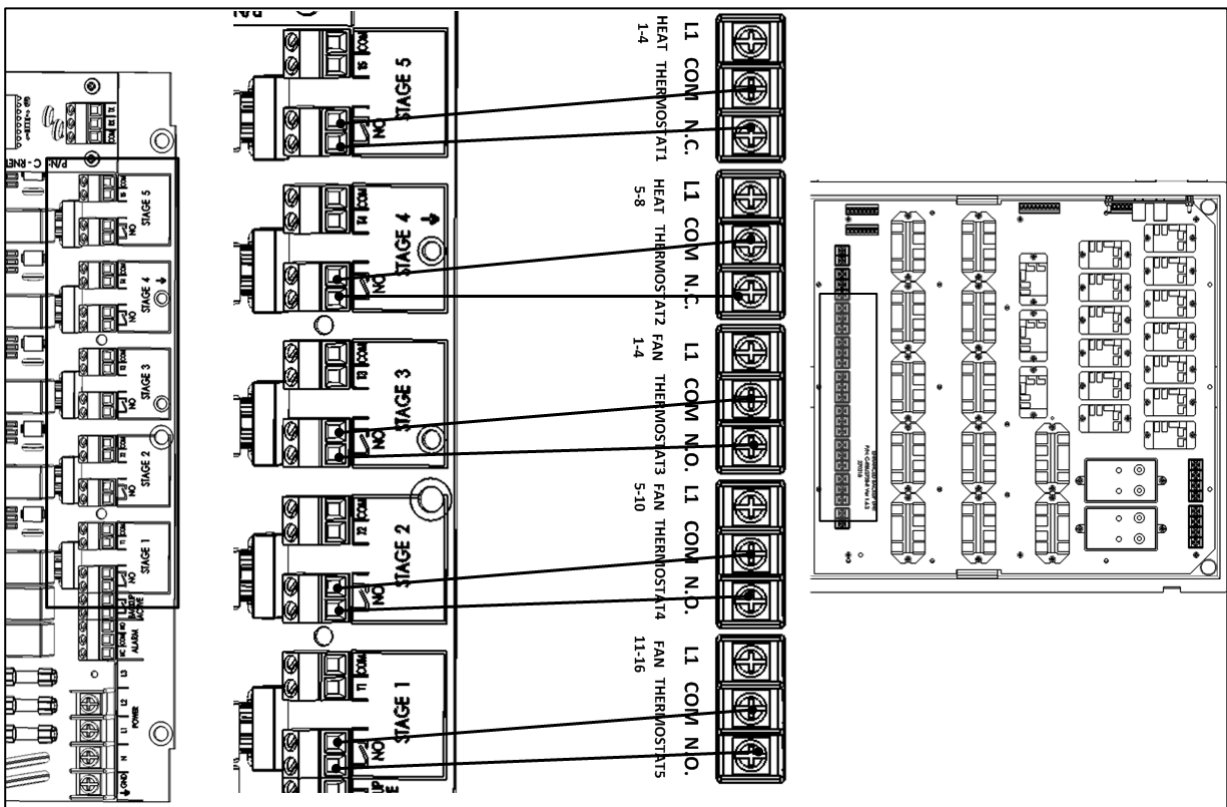

Figure 7: Wiring Between RDT-5 and FBU-27 SE

5.2.3 RDT-5 – RTS WIRING

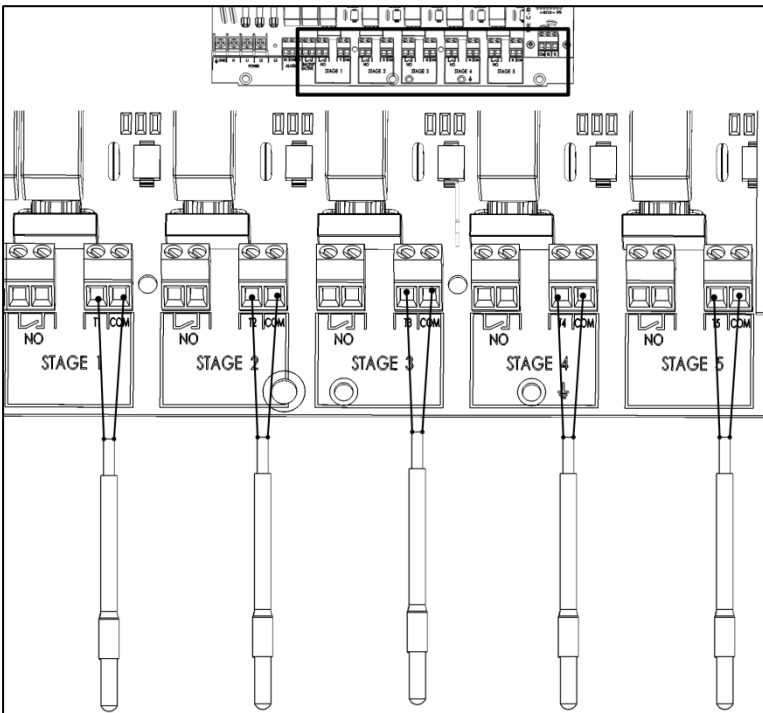

Figure 8: Wiring Between RDT-5 and RTS-2

NOTE Ensure that each temperature sensor is installed correctly in the required location.

NOTE If a 30 Kohm resistor is installed in place of a temperature sensor, the stage is non-operational. To enable stage operation, remove the resistor and install a sensor.

CAUTION Any stage having neither a sensor nor a resistor causes an alarm (Sensor Failure Event).

5.2.4 POWERING THE RDT-5

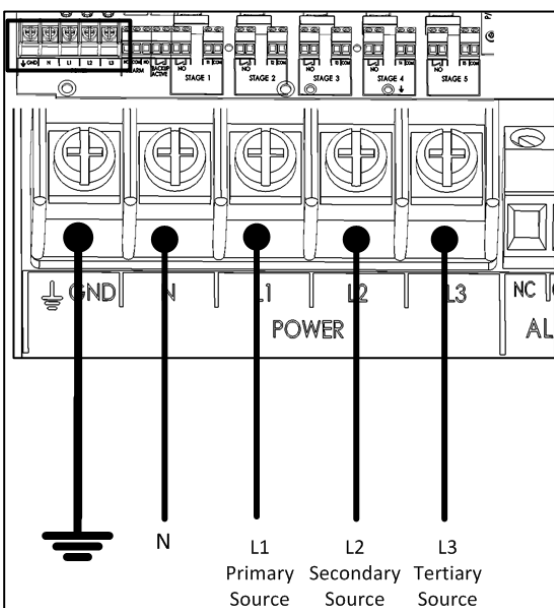

Figure 9: Powering the RDT-5

CAUTION When powering the RDT-5, the L1, L2, and L3 ports must be fed from different power sources, phases, or breakers.

5.2.5 ALARM WIRING

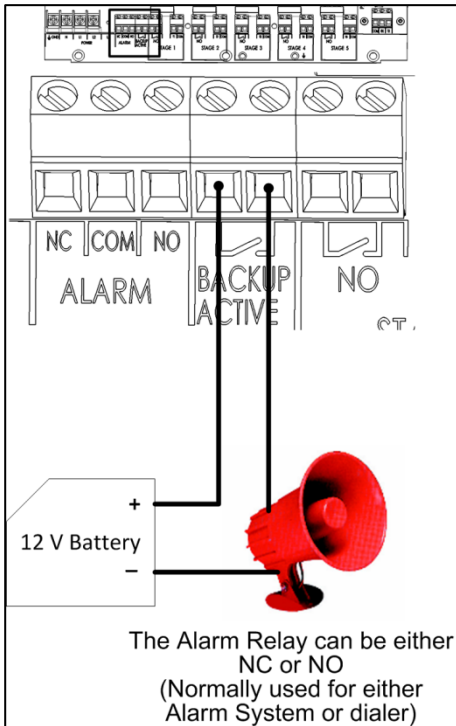

Figure 10: Alarm Port Wiring

An alarm is triggered when:

- either the primary or secondary power source fails
- a sensor is shorted or fails to operate
- the CPU fails

Note that even if the CPU ceases to operate, the RDT-5 continues to function. The CPU does not run the unit; it is used only to enter the unit parameters.

5.2.6 PLATINUM – RDT-5 WIRING

The RDT-5 can be wired directly to the Platinum's digital input card. In this configuration, RDT-5 can provide two functions:

- The Platinum transmits an alarm to a PC in the event of a RDT-5 power or sensor failure. In this configuration the RDT-5 functions when the Platinum has a problem with its:
 - relays
 - breakers
 - sensors
- The Platinum transmits an alarm when RDT-5 activates one of the stages

CAUTION While both of these functions are optional, Munters strongly recommends wiring the RDT-5 to Platinum Controllers.

5.2.7 PLATINUM – RDT-5 COMMUNICATION

- Platinum 5.10 and above support RS-485 communication with the RDT-5.
- All Platinum versions support RS-232 communication with the RDT-5.

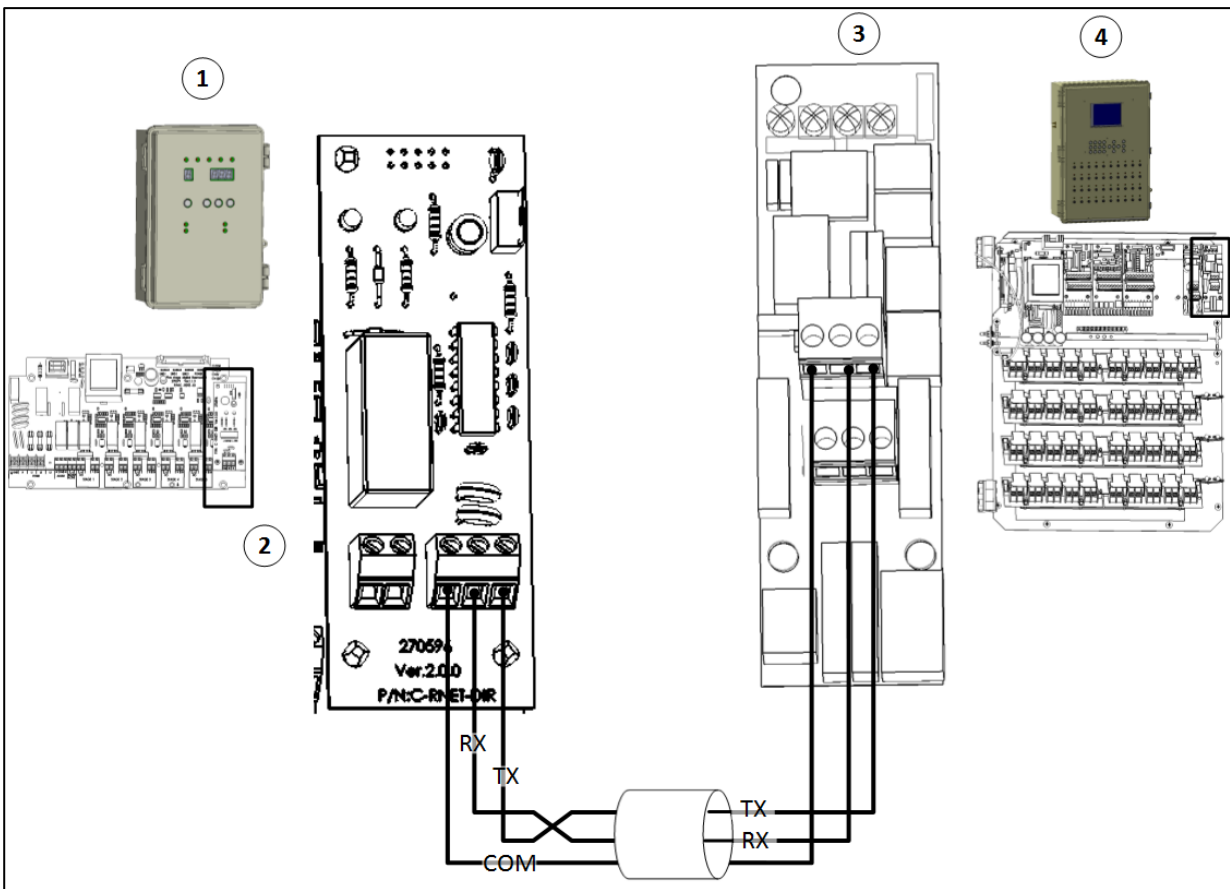

Figure 12: RDT-5 to Platinum RS-232 Communication

Figure 12 key	
1	RDT-5 Unit
2	RDT-5 Communication Card RS-232 Direct
3	Platinum PP-232_485 Communication Card
4	Platinum Controller

NOTE: When using RS-232 cabling, place the RDT-5 within 10 meters of the controller.

CAUTION The RS-232 Communication Card comes prewired to the RDT-5 Alarm NO and COM ports. When wiring the RDT-5 to a Digital Card (RDIC), leave this wiring in place and connect RDIC wiring to the same ports.

WARNING! If your RDT-5 is equipped with a C-RNET-DIR Ver 1.0.0 communication card, contact your dealer about an upgrade.

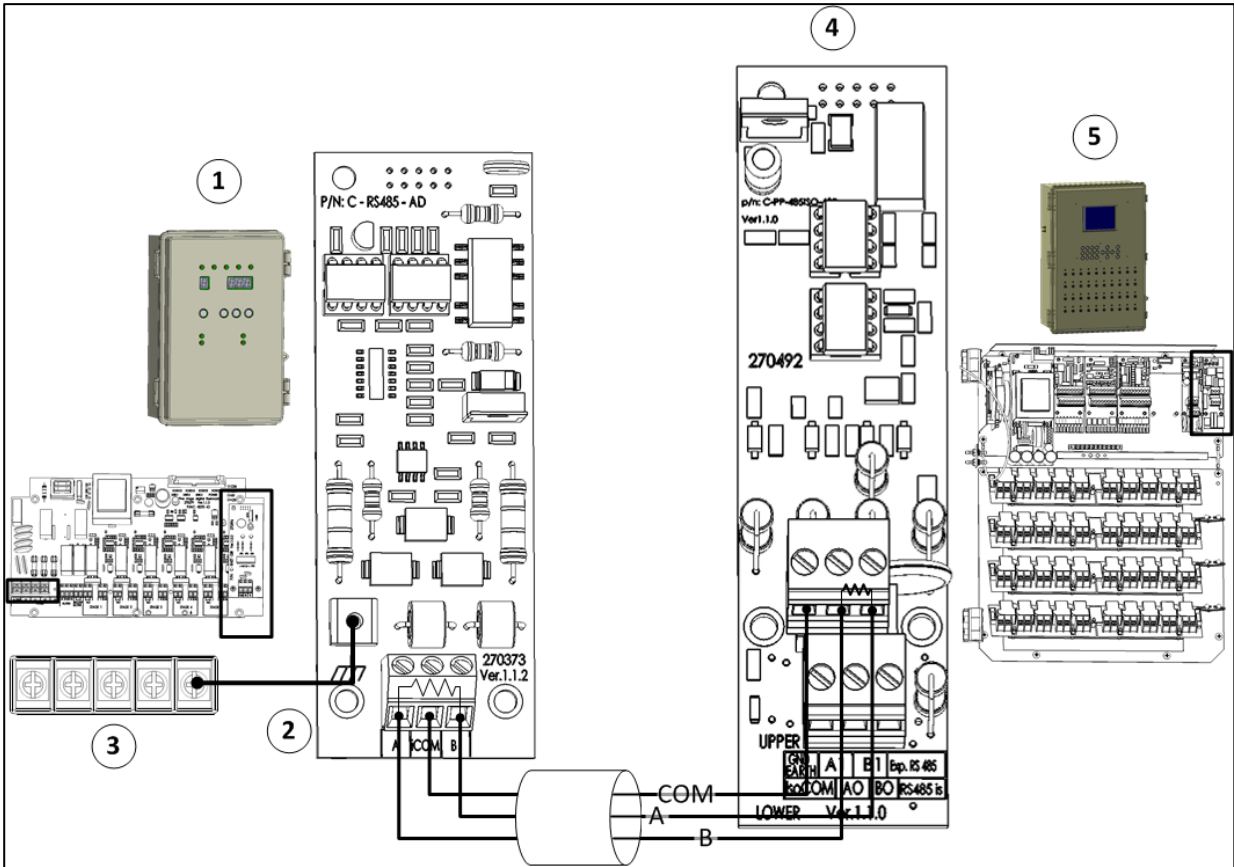

Figure 13: RDT-5 to Platinum RS-485 Communication

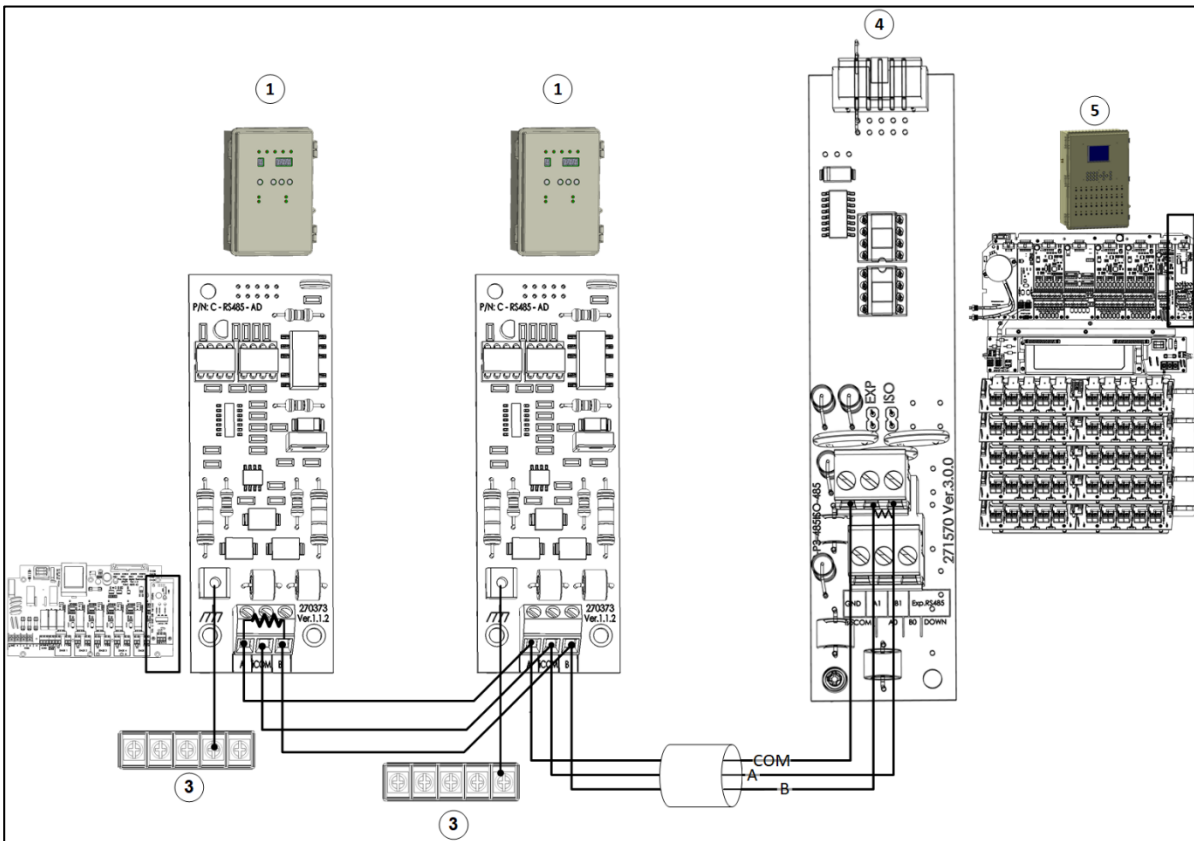

Figure 14: Two RDT-5 to Platinum RS-485 Communication (Version 6.20/7.20)

CAUTION To ensure effective signal transmission, install a 120 ohm resistor between ports A and B on both the RDT-5 Communication Card and the Platinum RS-485 Communication Card.

Figure 13 key	
1	RDT-5 Unit
2	RDT-5 Communication Card RS-485
3	RDT-5 ground strip
4	Platinum PP-485ISO_485 Communication Card
5	Platinum Controller

5.3 Configuring the RS-485 Communication

Configuring the RS-485 communication consists of:

- Defining the 5V Status
- Defining the Termination
- Defining the Baud Rate

SW	STATE	DESCRIPTION
S1	ON	+5V
	OFF	
S2	ON	TERMINATION
	OFF	NO TERMINATION
S3	ON	115K bit/sec
	OFF	9600/19200 bit/sec

Figure 15: Communication Board Dipswitches

The following section provides guidelines on how to set the RNET-485i Card dipswitches.

- (5V): Always enable (5V) in the RDT-5.
- Termination
 - Termination is required in each chain, in the beginning and in the end units.
 - When RDT-5 is a beginning or end unit, enable 120 ohm termination using the S2 dipswitch.
- 115k bit/sec: This speed is always on.

The illustrations below demonstrate these principles:

- (5V) means RDT-5 supplies 5V

Table 3: RDT-5 at Chain endpoint: Termination, (5V), Baud Rate

(5V) S1	Termination S2	Baud Rate S3
On	On	On

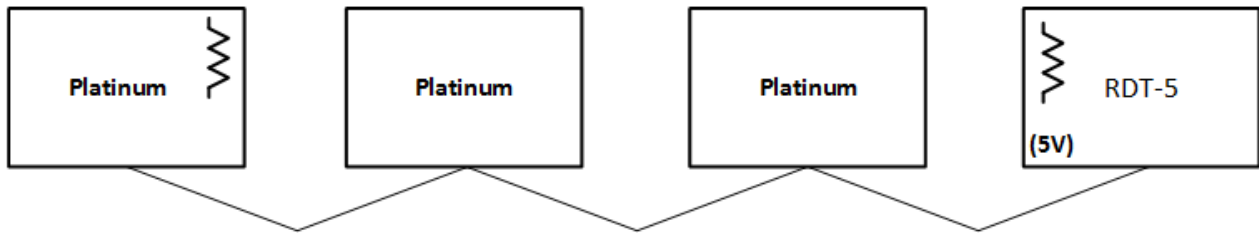

Figure 16: RDT-5 at Chain Endpoint

Table 4: RDT-5 in Mid Chain: Termination, (5V), Baud Rate

(5V) S1	Termination S2	Baud Rate S3
On	Off	On

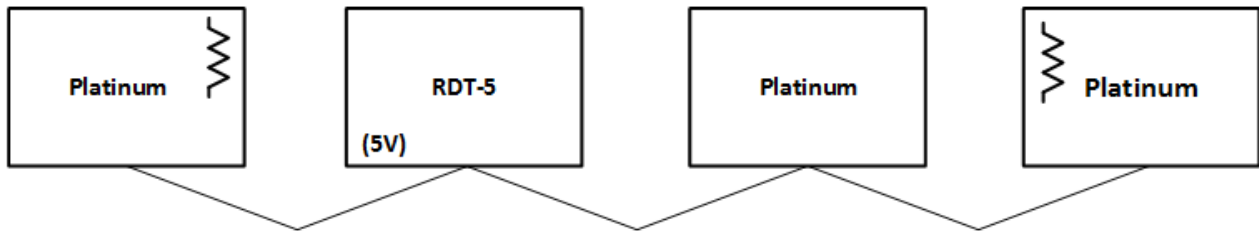





Figure 17: RDT-5 in Middle

6 Specifications

Power Supply	
Mains voltage primary	Triple phase, 115 VAC
Main fuse primary	5 A
Secondary fuse	1.25 A
Maximum power consumption	10 VA
Available power for peripheral equipment	
Relays Outputs	
6 N.O. power relay	5 Amps, 250 VAC
1 N.O/N.C power relay	5 Amps, 250 VAC
Housing	
Dimensions (L x W x H)	30 x 20 x 15 cm
Ambient Climate	
Operating temperature range	14° to 140° F
Analog inputs	5 temperature inputs
Certification	  

CAUTION RDT-5 ceases to operate outside of the operating temperature range.

7 Appendix A: Setting the Temperature Curve In Legacy Software

RDT-5 enables setting a three point/three day temperature curve.

To configure the temperature curve:

1. Press Up Arrow for three seconds.

The three digits display F.d and 1 (Stage 1).

2. Use the arrow keys to set the day.

3. Press Select.

The three digits display F.t and the current curve setting.

4. Use the arrow keys to set the curve setting.

5. Press Select.

The three digits display S.d and the current value.

6. Use the arrow keys to set the day.

7. Press Select.

The three digits display S.t and the current curve setting.

8. Use the arrow keys to set the curve setting.

9. Press Select.

The three digits display L.d and the current value.

10. Use the arrow keys to set the day.

11. Press Select.

The three digits display L.t and the current curve setting.

12. Use the arrow keys to set the day.

13. Press Select.

- Values are saved to memory.
- The display returns to the Main Screen.

NOTE After 60 seconds of inactivity on the keyboard, the display automatically returns to the Main Screen.

8 Warranty

Warranty and technical assistance

Munters products are designed and built to provide reliable and satisfactory performance but cannot be guaranteed free of faults; although they are reliable products they can develop unforeseeable defects and the user must take this into account and arrange adequate emergency or alarm systems if failure to operate could cause damage to the articles for which the Munters plant was required: if this is not done, the user is fully responsible for the damage which they could suffer.

Munters extends this limited warranty to the first purchaser and guarantees its products to be free from defects originating in manufacture or materials for one year from the date of delivery, provided that suitable transport, storage, installation and maintenance terms are complied with. The warranty does not apply if the products have been repaired without express authorisation from Munters, or repaired in such a way that, in Munters' judgement, their performance and reliability have been impaired, or incorrectly installed, or subjected to improper use. The user accepts total responsibility for incorrect use of the products.

The warranty on products from outside suppliers fitted to the RDT-5, (for example cables, sensors, etc.) is limited to the conditions stated by the supplier: all claims must be made in writing within eight days of the discovery of the defect and within 12 months of the delivery of the defective product. Munters has thirty days from the date of receipt in which to take action, and has the right to examine the product at the customer's premises or at its own plant (carriage cost to be borne by the customer).

Munters at its sole discretion has the option of replacing or repairing, free of charge, products which it considers defective, and will arrange for their despatch back to the customer carriage paid. In the case of faulty parts of small commercial value which are widely available (such as bolts, etc.) for urgent despatch, where the cost of carriage would exceed the value of the parts, Munters may authorise the customer exclusively to purchase the replacement parts locally; Munters will reimburse the value of the product at its cost price.

Munters will not be liable for costs incurred in demounting the defective part, or the time required to travel to site and the associated travel costs. No agent, employee or dealer is authorised to give any further guarantees or to accept any other liability on Munters' behalf in connection with other Munters products, except in writing with the signature of one of the Company's Managers.

WARNING: In the interests of improving the quality of its products and services, Munters reserves the right at any time and without prior notice to alter the specifications in this manual.

The liability of the manufacturer Munters ceases in the event of:

- dismantling the safety devices;
- use of unauthorised materials;
- inadequate maintenance;
- use of non-original spare parts and accessories.

Barring specific contractual terms, the following are directly at the user's expense:

- preparing installation sites;
- providing an electricity supply (including the protective equipotential bonding (PE) conductor, in accordance with CEI EN 60204-1, paragraph 8.2), for correctly connecting the equipment to the mains electricity supply;
- providing ancillary services appropriate to the requirements of the plant on the basis of the information supplied with regard to installation;
- tools and consumables required for fitting and installation;
- lubricants necessary for commissioning and maintenance.

It is mandatory to purchase and use only original spare parts or those recommended by the manufacturer.

Dismantling and assembly must be performed by qualified technicians and according to the manufacturer's instructions.

The use of non-original spare parts or incorrect assembly exonerates the manufacturer from all liability.

Requests for technical assistance and spare parts can be made directly to the nearest [Munters office](#).

